

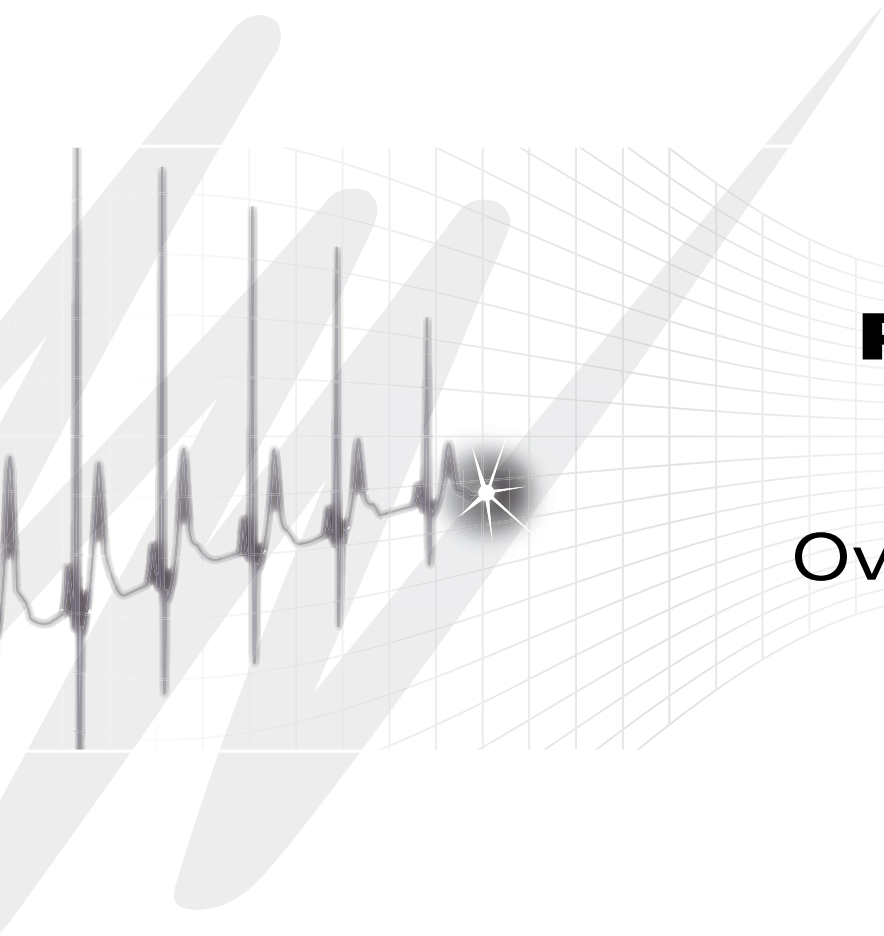

**PowerLab<sup>®</sup>**  
**/35 Series**  
Owner's Guide





**PowerLab<sup>®</sup>**  
**/35 Series**  
Owner's Guide



This document was, as far as possible, accurate at the time of release. However, changes may have been made to the software and hardware it describes since then. ADInstruments Pty Ltd reserves the right to alter specifications as required. Late-breaking information may be supplied separately.

### **Trademarks of ADInstruments**

PowerLab®, LabChart®, LabTutor®, LabAuthor® and MacLab® are registered trademarks of ADInstruments Pty Ltd. The names of specific recording units, such as PowerLab 8/35, are trademarks of ADInstruments Pty Ltd. LabTutor Server, Chart and Scope (application programs) and LabTutor Online are trademarks of ADInstruments Pty Ltd.

### **Other Trademarks**

Apple, Mac and Macintosh are registered trademarks of Apple Computer, Inc.

Windows, Windows 7 and Windows Vista are either registered trademarks or trademarks of Microsoft Corporation.

All other trademarks are the property of their respective owners.

Product: PL3504 PowerLab 4/35; PL3508 PowerLab 8/35; PL3516 PowerLab 16/35

Document Number: U-PL35XX/OG-35E

Part Number: 5761-E

Copyright © 2014 ADInstruments Pty Ltd.  
Unit 13, 22 Lexington Drive, Bella Vista, NSW 2153, Australia

All rights reserved. No part of this document may be reproduced by any means without the prior written permission of ADInstruments Pty Ltd.

Web: [www.adinstruments.com](http://www.adinstruments.com)  
Technical Support: [support.au@adinstruments.com](mailto:support.au@adinstruments.com)  
Documentation: [documentation@adinstruments.com](mailto:documentation@adinstruments.com)

# Contents

<b>Safety Notes</b>	<b>5</b>
<b>1 Overview</b>	<b>13</b>
How to Use This Guide . . . . .	14
The PowerLab System . . . . .	14
First, Install the Software . . . . .	14
Next, Check Your PowerLab . . . . .	15
Other ADInstruments Hardware . . . . .	15
The PowerLab . . . . .	16
The Front Panel . . . . .	16
The Back Panel . . . . .	19
<b>2 Setting Up</b>	<b>23</b>
The PowerLab Self-test . . . . .	24
Connecting the PowerLab . . . . .	25
<b>A Technical Aspects</b>	<b>27</b>
How it Works . . . . .	28
The Analog Inputs . . . . .	29
The Analog Outputs . . . . .	30
PowerLab Accuracy . . . . .	30
The External Trigger . . . . .	31
Connections . . . . .	32
Pod Connectors . . . . .	32
Serial Port . . . . .	32
I <sup>2</sup> C Expansion Socket . . . . .	33
Digital Input and Output Sockets . . . . .	33
USB Connections . . . . .	34
Earthing and Ground Loop Noise . . . . .	34
<b>B Specifications</b>	<b>37</b>
<b>C Declaration of Conformity</b>	<b>43</b>
<b>D Glossary</b>	<b>45</b>



# Safety Notes

## Statement of Intended Use

All products manufactured by ADInstruments are intended for use in teaching and research applications and environments only. ADInstruments products are NOT intended to be used as medical devices or in medical environments. That is, no product supplied by ADInstruments is intended to be used to diagnose, treat or monitor a subject. Furthermore no product is intended for the prevention, curing or alleviation of disease, injury or handicap.

Where a product meets IEC 60601-1 it is under the principle that this is a more rigorous standard than other standards that could be chosen, and it provides a high safety level for subjects and operators.

The choice to meet IEC 60601-1 is in no way to be interpreted to mean that a product:

- is a medical device,
- may be interpreted as a medical device, or
- is safe to be used as a medical device.

## Safety and Quality Standards

When used with ADInstruments isolated front-ends, PowerLab systems are safe for connection to subjects. The FE132 Bio Amp, FE135 Dual Bio Amp, FE136 Animal Bio Amp, FE185 Neuro Amp EX, ML408 Dual Bio Amp/Stimulator, FE116 GSR Amp, FE117 BP Amp and FE180 Stimulus Isolator front-ends conform to international safety requirements. Specifically these are IEC60601-1 and its addenda (Safety Standards, page 7) and various harmonized standards worldwide (CSA601.1 in Canada and AS/NZS 3200.1 in Australia and New Zealand).

In accordance with European standards they also comply with the electromagnetic compatibility requirements under EN61326-1, which encompasses the EMC directive.

## Quality Management System ISO 9001:2008

ADInstruments manufactures products under a quality system certified as complying with ISO 9001:2008 by an accredited certification body.

## Safety Symbols

Devices manufactured by ADInstruments that are designed for direct connection to humans are tested to IEC60601-1:1998 (including amendments 1 and 2) and EN61326-1:2006, and carry one or more of the safety symbols below. These symbols appear next to those inputs and output connectors that can be directly connected to human subjects.



BF (body protected) symbol. This means that the input connectors are suitable for connection to humans provided there is no direct electrical connection to the heart.



Warning symbol. The exclamation mark inside a triangle means that the supplied documentation must be consulted for operating, cautionary or safety information before using the device.



CE Mark. All PowerLab systems and front-end amplifiers carry the CE mark and meet the appropriate EU directives.



UL Mark. ADInstruments isolated preamplifiers and 35 series PowerLab data acquisition units meet standards for Data Recorders set by UL (Underwriters Laboratories) with respect to electrical shock, fire and mechanical hazards only, in accordance with CAN/CSA-C22.2 No. 601.1 and UL 60601-1. The UL mark shown refers only to the PowerLab. For all other equipment, refer to the relevant documentation.

DATA RECORDER WITH  
RESPECT TO ELECTRICAL  
SHOCK, FIRE AND  
MECHANICAL HAZARDS  
ONLY IN ACCORDANCE  
WITH CAN/CSA-C22.2 No.  
601.1 AND UL 60601-1

Further information is available on request.

---

# Safety Standards

## IEC Standard - International Standard - Medical Electrical Equipment

- IEC60601-1:1998: General requirements for safety
- IEC60601-1-1:1992: Safety requirements for medical electrical systems
- EN61326-1:2006: Electrical equipment for measurement, control and laboratory use – EMC requirements

## UL Standard - Medical Electrical Equipment

- UL 60601-1: Medical Electrical Equipment, Part 1: General Requirements for Safety – Edition 1
- CSA C22.2 No. 601.1: Medical Electrical Equipment, Part 1: General Requirements for Safety – Edition 1

# Declaration of Conformity

A Declaration of Conformity covering 2004/108/EC Electromagnetic Compatibility (EMC) and 2006/95/EC Low Voltage Equipment directives can be found in Appendix C of this owner's guide.

# General Safety Instructions

To achieve the optimal degree of subject and operator safety, consideration should be given to the following guidelines when setting up a PowerLab system either as stand-alone equipment or when using PowerLab equipment in conjunction with other equipment. Failure to do so may compromise the inherent safety measures designed into PowerLab equipment. The following guidelines are based on principles outlined in the international safety standard IEC60601-1-1: *General requirements for safety - Collateral standard: Safety requirements for medical systems*. Reference to this standard is required when setting up a system for human connection. The user is responsible for ensuring any particular configuration of equipment complies with IEC60601-1-1.

PowerLab systems (and many other devices) require the connection of a personal computer for operation. This personal computer should be certified as complying with IEC60950, should be located outside a 1.8 m radius from the subject (so that the subject cannot touch it while connected to the system). Within this 1.8 m radius, only equipment complying with IEC60601-1 should be present. Connecting a system in this way obviates the provision of additional safety measures and the measurement of leakage currents.

---

Accompanying documents for each piece of equipment in the system should be thoroughly examined prior to connection of the system. While it is not possible to cover all arrangements of equipment in a system, some general guidelines for safe use of the equipment are presented below:

- Any electrical equipment which is located within the SUBJECT AREA should be approved to IEC60601-1.
- Only connect those parts of equipment that are marked as an APPLIED PART to the subject. APPLIED PARTS may be recognized by the BF symbol which appears in the Safety Symbols section of these Safety Notes.
- Never connect parts which are marked as an APPLIED PART to those which are not marked as APPLIED PARTS.
- Do not touch the subject to which the PowerLab (or its peripherals) is connected at the same time as making contact with parts of the PowerLab (or its peripherals) that are not intended for contact to the subject.
- Cleaning and sterilization of equipment should be performed in accordance with manufacturer's instructions. The isolation barrier may be compromised if manufacturer's cleaning instructions are not followed.
- The ambient environment (such as the temperature and relative humidity) of the system should be kept within the manufacturer's specified range or the isolation barrier may be compromised.
- The entry of liquids into equipment may also compromise the isolation barrier. If spillage occurs, the manufacturer of the affected equipment should be contacted before using the equipment.
- Many electrical systems (particularly those in metal enclosures) depend upon the presence of a protective earth for electrical safety. This is generally provided from the power outlet through a power cord, but may also be supplied as a dedicated safety earth conductor. Power cords should never be modified so as to remove the earth connection. The integrity of the protective earth connection between each piece of equipment and the protective earth should be verified regularly by qualified personnel.
- Avoid using multiple portable socket-outlets (such as power boards) where possible as they provide an inherently less safe environment with respect to electrical hazards. Individual connection of each piece of equipment to fixed mains socket-outlets is the preferred means of connection.

If multiple portable socket outlets are used, they are subject to the following constraints:

- They shall not be placed on the floor.
- Additional multiple portable socket outlets or extension cords shall not be connected to the system.
- They shall only be used for supplying power to equipment which is intended to form part of the system.



---

## Cleaning and Sterilization

ADInstruments products may be wiped down with a lint free cloth moistened with industrial methylated spirit. Refer to the manufacturer's guidelines or the Data Card supplied with transducers and accessories for specific cleaning and sterilizing instructions.

## Preventative Inspection and Maintenance

PowerLab systems and ADInstruments front-ends are all maintenance-free and do not require periodic calibration or adjustment to ensure safe operation. Internal diagnostic software performs system checks during power up and will report errors if a significant problem is found. There is no need to open the instrument for inspection or maintenance, and doing so within the warranty period will void the warranty.

Your PowerLab system can be periodically checked for basic safety by using an appropriate safety testing device. Tests such as earth leakage, earth bond, insulation resistance, subject leakage and auxiliary currents and power cable integrity can all be performed on the PowerLab system without having to remove the covers. Follow the instructions for the testing device if performing such tests.

If the PowerLab system is found not to comply with such testing you should contact your PowerLab representative to arrange for the equipment to be checked and serviced. Do not attempt to service the device yourself.

## Environment

Electronic components are susceptible to corrosive substances and atmospheres, and must be kept away from laboratory chemicals.

### Storage Conditions

- Temperature in the range 0–40 °C
- Non-condensing humidity in the range 0–95%.

### Operating Conditions

- Temperature in the range 5–35 °C
- Non-condensing humidity in the range 0–90%.

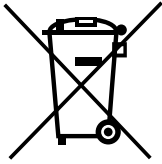

WEEE Directive  
symbol

## Disposal

- Forward to recycling center or return to manufacturer.
- Unwanted equipment bearing the Waste Electrical and Electronic Equipment (WEEE) Directive symbol requires separate waste collection. For a product labeled with this symbol, either forward to a recycling center or contact your nearest ADInstruments representative for methods of disposal at the end of its working life.

## Bio Amp Safety Instructions

The Bio Amp inputs displaying any of the safety symbols are electrically isolated from the mains supply in order to prevent current flow that may otherwise result in injury to the subject. Several points must be observed for safe operation of the Bio Amp:

- The Bio Amp front-ends (*except for the ML138 Octal Bio Amp*) and all PowerLab units with a built-in Bio Amp are supplied with a 3-lead or 5-lead Bio Amp subject cable and lead wire system. The ML138 Octal Bio Amp is supplied with unshielded lead wires (1.8 m). Bio Amps are only safe for human connection if used with the supplied subject cable and lead wires.
- All Bio Amp front-ends and PowerLab units with a built-in Bio Amp are not defibrillator-protected. Using the Bio Amp to record signals during defibrillator discharges may damage the input stages of the amplifiers. This may result in a safety hazard.
- Never use damaged Bio Amp cables or leads. Damaged cables and leads must always be replaced before any connection to humans is made.

## Isolated Stimulator Safety Instructions

The Isolated Stimulator outputs of a front-end signal conditioner or PowerLab with a built-in isolated stimulator are electrically isolated. However, they can produce pulses of up to 100 V at up to 20 mA. Injury can still occur from careless use of these devices. Several points must be observed for safe operation of the Isolated Stimulator:

- The Isolated Stimulator output must only be used with the supplied bar stimulus electrode.
- The Isolated Stimulator output must not be used with individual (physically separate) stimulating electrodes.

- 
- Stimulation must not be applied across the chest or head.
  - Do not hold one electrode in each hand.
  - Always use a suitable electrode cream or gel and proper skin preparation to ensure a low-impedance electrode contact. Using electrodes without electrode cream can result in burns to the skin or discomfort for the subject.
  - Subjects with implantable or external cardiac pacemakers, a cardiac condition, or a history of epileptic episodes must not be subject to electrical stimulation.
  - Always commence stimulation at the lowest current setting and slowly increase the current.
  - Stop stimulation if the subject experiences pain or discomfort.
  - Do not use faulty cables, or those that have exhibited intermittent faults.
  - Do not attempt to measure or record the Isolated Stimulator waveform while connected to a subject using a PowerLab input or any other piece of equipment that does not carry the appropriate safety symbol – See “Safety Symbols” on page 6.

Always check the status indicator on the front panel. It will always flash green each time the stimulator delivers a current pulse. A yellow flash indicates an ‘out-of-compliance’ (OOC) condition that may be due to the electrode contact drying up. Always ensure that there is good electrode contact at all times. Electrodes that are left on a subject for some time need to be checked for dry contacts. An electrode impedance meter can be used for this task.

- Always be alert for any adverse physiological effects in the subject. At the first sign of a problem, stimulation must be stopped, either from the software or by flicking down the safety switch on the front panel of any built-in Isolated Stimulator or the FE180 Stimulus Isolator.

The FE180 Stimulus Isolator is supplied with a special transformer plug pack. The plug pack complies with medical safety requirements. Therefore, under no circumstances should any other transformer be used with the Stimulus Isolator. For a replacement transformer plug pack please contact your nearest ADInstruments representative.



# Overview

Your PowerLab® recording unit, together with a range of specialized application programs, provides a versatile data recording and analysis system when used with a Windows or Macintosh computer. This chapter provides an overview of the PowerLab system and describes the basic features, connectors and indicators of the /35 series PowerLabs.

Note that the software on the Software Installer CD should be installed before you connect the PowerLab to your computer.

---

# How to Use This Guide

This owner's guide describes how to set up and begin using your PowerLab recording unit. The chapters provide an overview of the PowerLab system (the combined software and hardware package), and a more detailed look at the features of your recording unit and its connection to your computer. The appendices provide technical information about the recording unit and solutions to problems. At the end of this guide is a glossary of hardware terms and an index.

The specifications and diagrams included in the appendices are there to help the more technically minded users to understand what the PowerLab can and cannot do; they are not there for use as a service manual. Note: only an authorized ADInstruments representative should repair the unit. If you modify the recording unit yourself, you void any rights you have under warranty.

The user's guides for the LabChart and Scope application programs provide detailed information about using the software of the PowerLab system for acquiring, storing and analyzing data. Read them after you have connected the PowerLab to your computer.

## The PowerLab System

The PowerLab system is an integrated system of hardware and software designed to record, display and analyze experimental data. The hardware includes the PowerLab recording unit and various ancillary devices (front-ends, pods and so on); the software consists of the LabChart and Scope application programs, and supplementary modules and extensions, which run on the computer to which the PowerLab is connected.

Your /35 PowerLab has considerable computing power of its own and performs many tasks during data recording. Once the PowerLab transfers data to the computer, it is available for display, manipulation, printing, storage and retrieval. The PowerLab 4/35 has four inputs for recording external signals, the 8/35 has eight and the 16/35 has sixteen.

### First, Install the Software

Depending on how you purchased your PowerLab you may have been provided with the LabChart and/or LabTutor applications. The LabChart application package provides many powerful features for the research environment, including channel calculations, triggering options, software-controlled stimulus generation and automated recording and analysis. LabChart emulates a multi-channel chart recorder (of up to 16 channels,

---

depending on the PowerLab model). The LabTutor application package provides an integrated solution for teaching life science laboratory courses, whilst maintaining much of the functionality of LabChart. LabTutor 4 also offers the option of using LabTutor Online to allow students offsite access to experiments. Please consult their user's guides for full descriptions.

You must install the software to use your PowerLab. Full installation instructions are included in the *Getting Started with PowerLab* manual.

## **Next, Check Your PowerLab**

Please do not attempt to connect the PowerLab to a power outlet or computer or turn it on until you have read the first two chapters of this guide, and have checked it as described below.

1. Check that all items in the accompanying packing list are included in the box.
2. Check that there are no signs of external damage to the PowerLab.
3. Check that there are no obvious signs of internal damage, such as rattling. Pick up the PowerLab, tilt it gently from side to side, and listen for anything that appears to be loose.

If anything is missing, or the PowerLab seems to be damaged in any way, contact your authorized ADInstruments representative immediately and describe the problem. Arrangements can be made to replace or repair the PowerLab. Up-to-date contact addresses are available in the software and from the ADInstruments website.

## **Other ADInstruments Hardware**

ADInstruments has a range of optional ancillary devices that can be connected to the PowerLab to extend the system's capabilities. They afford extra signal conditioning and other features, and extend the types of experiments you can conduct and the data you can record. Front-ends are advanced signal conditioners (the Bio Amp front-end, for instance, lets you perform electrically isolated measurements of biological signals). Pods are basic signal conditioners, more limited (but cheaper) than front-ends.

Both are automatically recognized by the PowerLab system and integrated into its programs, operating under full software control. Various transducers can plug into a PowerLab, front-end or pod, depending on their type. A PowerLab can usually have as many front-ends, pods, stand-alone instruments or transducers connected to it as it has appropriate connectors and available input channels. All are easily added to or transferred among

PowerLabs. Full information on such hardware is available from your local ADInstruments representative or from the ADInstruments website.

## The PowerLab

It is a good idea to get familiar with some of the external features of your PowerLab before connecting it to a power source. The rest of this chapter discusses the different features, connectors and indicators of the /35 series PowerLabs.

### The Front Panel

The front panel of your PowerLab provides most of the connectors for obtaining external signals, and indicators for various functions.

The PowerLab 4/35 has three indicators at the left of the front panel, one BNC connector for the external trigger, two BNC connectors for analog output and four BNC connectors (marked Input 1 – 4) with four alternative pod (DIN) connectors for Inputs 1 – 4, for recording external signals.

**Figure 1–1**  
The front panel of the  
PowerLab 4/35

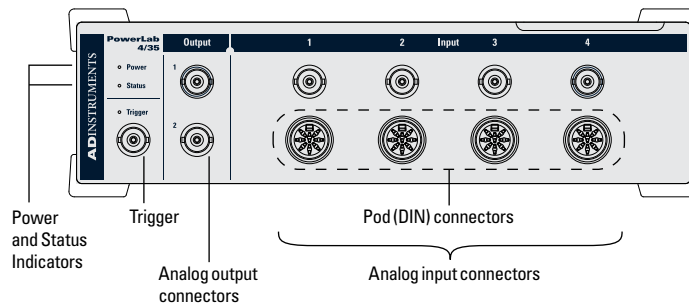

The front panel of the PowerLab 8/35 is similar to the PowerLab 4/35 except it has eight BNC connectors (marked Input 1 – 8) with four alternative pod (DIN) connectors for Inputs 1 – 4, for recording external signals.

**Figure 1–2**  
The front panel of the  
PowerLab 8/35

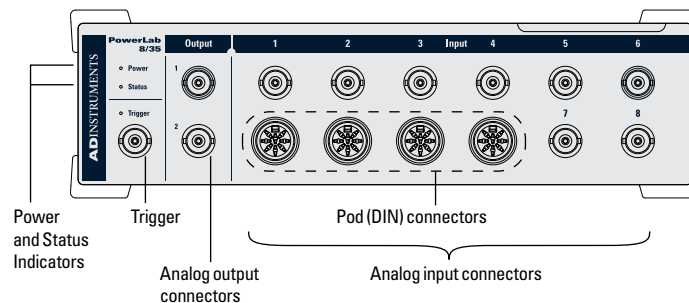



The front panel of the PowerLab 16/35 is also similar to the other two PowerLabs except it has sixteen BNC connectors (marked Input 1 – 16) with four alternative pod (DIN) connectors for Inputs 1 – 4, for recording external signals.

**Figure 1–3**  
The front panel of the  
PowerLab 16/35

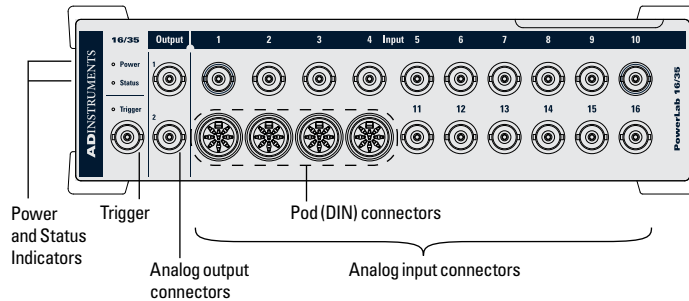

### Indicators

All three labeled indicators on the front panel should turn on at least briefly while the PowerLab is started up. Under normal conditions, the Power indicator should glow blue and then stay lit, the Status indicator should flash yellow and then stay green and the Trigger indicator should flash yellow and then turn off. The Power indicator is a blue light, which simply shows that the PowerLab is getting power. When an external trigger signal is received, the Trigger indicator will glow yellow.

The Status indicator provides some visual indication of what the PowerLab is doing, and will flash different patterns and colors depending on the state of the PowerLab.

**Table 1–1**  
Status indicator states

<i>Status Indicator</i>	<i>Meaning</i>
Off	Idle and not yet initialized by the software.
Green	Idle, initialized, and waiting for a command from the computer.
Yellow	Sampling, or communicating with the computer.
Four red flashes then one yellow	The PowerLab has detected a low-level software or hardware fault. It will repeat until the PowerLab is turned off.
Red flashes	The PowerLab has detected an internal fault during the power-up test. It will repeat until the PowerLab is turned off.

---

## Trigger

The external trigger connector allows you to use an external signal to synchronize recording to the external event. This input can handle voltages of up to  $\pm 12$  V. The threshold voltage (the voltage above which the trigger circuit activates) is 1.5 volts for a rising edge. When the trigger threshold is crossed, the indicator beside the external trigger connector will glow yellow. The external trigger is described in more detail on page 31, and the software documentation covers its practical use in normal recording.

## Analog Output

The PowerLab can generate a stimulus voltage through analog output connectors (marked Output 1 and Output 2), giving positive, negative, differential, or independent stimuli, depending on the connectors used and the software settings. By default, the outputs are used for complementary (differential) stimulation, where Output 1 is positive and Output 2 is negative. When Output 1 is used, a positive stimulus (set up in the software) gives a positive voltage, and a negative stimulus gives a negative voltage. When Output 2 is used, the voltage outputs are inverted. When both outputs are used, the stimulus is the difference between the voltages at the positive and negative outputs: a pulse of 20 V could be generated using a setting of  $\pm 10$  V.

## Analog Inputs

The analog inputs receive external signals up to  $\pm 10$  V. Each input has an independently programmable gain amplifier, filtering, and AC/DC coupling. Set up each input with the software, for your requirements. Input signals can be as low as the microvolt ( $\mu\text{V}$ ) range without the need for external amplification. Note: applying more than  $\pm 15$  V to the analog inputs can damage the circuitry.

The PowerLab 4/35 has four independent analog inputs (Input 1 – 4), all of which have alternative connectors. The PowerLab 8/35 has eight independent analog inputs (Input 1 – 8), the first four of which have alternative connectors. The PowerLab 16/35 has sixteen independent analog inputs (Input 1 – 16), the first four of which have alternative connectors. The BNC connectors for Inputs 1 – 4 can be used for single-ended input, and the 8-pin DIN pod connectors can be used for either single-ended or differential input. Single-ended inputs record the difference between signal and ground, whereas differential inputs record the difference between positive and negative input signals.

On /35 series PowerLabs, the impedance between the earthing stud (ground connection) and the input connector grounds is 100 Ohms.

Do not attempt to record from both the BNC and DIN pod connectors for any one input at the same time, or the signals will compete.

**⚠ WARNING**  
*The operator should not touch the I<sup>2</sup>C Output socket and the patient at the same time.*

Pod connectors allow the connection of ADInstruments pods, which are small, low-cost units designed for specific tasks, for use with precalibrated transducers. Transducers should not be connected directly to the pod connectors on a PowerLab, unless labeled to do so (unsuitable transducers will give a very weak signal). Transducers designed for direct connection receive power and control signals, since the pod connectors also provide some of the functions of the I<sup>2</sup>C output.

## The Back Panel

The PowerLab back panel provides the ports to connect the PowerLab to the computer, front-ends, the power outlet and so on. This section describes each of the back panel features. The back panel is the same for all the /35 series PowerLabs.

**Figure 1–4**  
The back panel of the PowerLab 4/35, 8/35 and 16/35

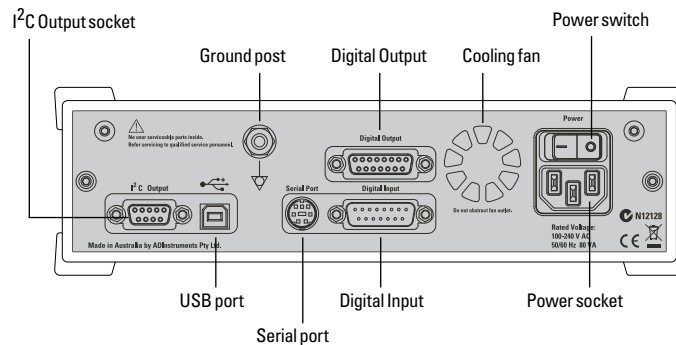

## I<sup>2</sup>C Output Socket

The I<sup>2</sup>C Output socket provides power and communications for ADInstruments front-ends. Many front-ends can be daisy-chained together and connected to the I<sup>2</sup>C port, as long as there are enough analog inputs on the PowerLab for the front-ends. The maximum current provided through this socket is 50 mA, so it should not be used for third-party devices that draw more current than that.

## USB port

The PowerLab connects to your computer by USB ports and a cable. This requires a computer with USB ports or a PCI USB card installed.

---

In most cases, you can turn on or off, or disconnect or reconnect, a USB-connected PowerLab safely while the computer remains on. However, you must not be running applications (LabChart or Scope) while you do this. Read the details on USB in Appendix A of this guide before connecting your PowerLab to your computer by USB.

### **Serial Port**

The PowerLab is fitted with an RS-485 serial communication port. It is not currently in use, but is meant for connection in the future to specialized devices controlled from the PowerLab system.

### **Digital Input and Output Sockets**

The Digital Input and Output sockets let you monitor and control external devices, respectively, with the PowerLab.

The digital input monitors state changes: you can have a predefined comment inserted automatically during recording, when a digital input changes to a particular state. The eight lines of the socket allow monitoring of up to eight devices. The Digital Output can turn external devices on and off, for example pumps, relays, and indicator lights, or can signal to some other device. The eight lines of the socket allow control of up to eight devices.

Technical details of the Digital Input and Output sockets are given in Appendix A. More information on the use of digital inputs and outputs is given in the user's guide for the software.

### **Cooling Fan**

The /35 series PowerLabs can generate a considerable amount of heat so they are fitted with a cooling fan. The cooling fan is visible in the rear panel of the PowerLab. It maintains sufficient airflow in the enclosure to keep the circuitry within operating temperatures. The fan outlet must be kept unobstructed, and far enough from walls or other devices (at least 3 inches or 8 cm), so as not to impede ventilation.

It is also important to ensure that the air inlets underneath the PowerLab are unobstructed. Blocking the grilles may result in the PowerLab heating up enough internally to affect the performance of the system and reduce reliability.

### **Ground Connection**

A special earthing (grounding) stud is provided on the rear panel of the PowerLab. This is an equipotential bonding connection post compatible with the DIN 42801 standard. The earthing stud is directly connected to the earth pin of the power socket and the PowerLab chassis. It is used as a primary

**❑ WARNING**  
*The operator should not touch the I<sup>2</sup>C Output socket and the patient at the same time.*

---

earth connection (equipotential connection point) in situations that require this type of connection, or if there is no ground provided via the power cord. Safety standards in laboratories and similar environments may require additional grounding protection when connecting equipment to human subjects, and their relevant standards or guidelines should be observed.

### **Power Connections**

The power switch on the back right of the PowerLab turns the PowerLab on and off; the 3-pin IEC power socket is used to connect your PowerLab to a 3-pin earthed (grounded) power cable. The power supply is universal, and can use all common international mains power supplies (auto-switching, 90–250 V AC, 50/60 Hz).

The /35 PowerLabs are not fitted with replaceable fuses. The power supply is short-circuit protected, and should not damage the internal fuses unless a major fault develops. If that happens, the unit must be returned for service by qualified service personnel. Do not attempt to replace internal power supply fuses yourself.



# 2

## Setting Up

This chapter describes the PowerLab's internal self-test and the USB connection.

---

## The PowerLab Self-test

Now that you are familiar with some of the features of your PowerLab, you should check that it is working properly before you connect it to your computer.

The PowerLab performs a diagnostic self-test each time it is switched on, whether or not it is connected to a computer. To test that your PowerLab is functioning properly when you turn it on, follow the instructions below, and watch the indicators.

1. Connect the PowerLab to a power outlet using the power cable that came with your unit. Turn on the power at the wall.
2. Turn on the power switch located on the rear of the unit.

All three labeled indicators on the front panel should turn on, at least briefly, while the PowerLab is starting up. The Power indicator on the front panel should glow blue while the PowerLab is on (see page 17). If the internal diagnostic check finds no problems, the Status indicator will flash yellow and then stay green. (The Trigger indicator should flash yellow, when the trigger operates.)

If the indicators perform as described above, then your PowerLab has successfully performed its internal self-test, and it can be safely connected to your computer. If your PowerLab does not successfully complete its self-test, something is wrong.

If the Power indicator does not glow blue when the power switch is turned on, then there is a problem with the power source, power cable or PowerLab itself. Check the connections and cables.

If an error is detected during the self-test, the Status indicator will flash red. Flashing lights are used when the problem is one that prevents the PowerLab communicating with the computer, and so cannot be shown in the software. Four red flashes separated by a yellow flash mean there is a low-level software or hardware fault. Red flashes mean there is a hardware fault. (See Table 1-1 for details.)

Turn everything off, and then after at least five seconds turn the PowerLab back on again. This should clear a temporary problem. If it still continues to flash red, then the PowerLab may need repair.

If the PowerLab does not seem to be getting power, or the Status indicator flashes red even after restarting, refer to the ADInstruments tech support website [www.adinstruments.com/support/tsupport](http://www.adinstruments.com/support/tsupport) or contact your



authorized ADInstruments representative. Do not attempt to repair the PowerLab yourself.

If your PowerLab has successfully performed its internal self-test, read on to find out how to connect it to your computer.

## Connecting the PowerLab

**Figure 2–2**  
USB icon



Use the USB cable supplied with your PowerLab to connect the USB port on the back panel to the USB port on your computer, or to an active USB hub connected to the computer (see Figure 2–2). USB ports and cables should be marked with a trident-like icon (Figure 2–1) but some may have the letters ‘USB’ instead. USB cables are directional and can only be connected one way: the narrow rectangular plug connects to a hub (or the computer), and the squarer plug with the bevelled top connects to a USB device, such as the PowerLab. Further detail about USB connections is provided on page 34 of Appendix A.

**Figure 2–1**  
Connecting a PowerLab  
to a computer with USB

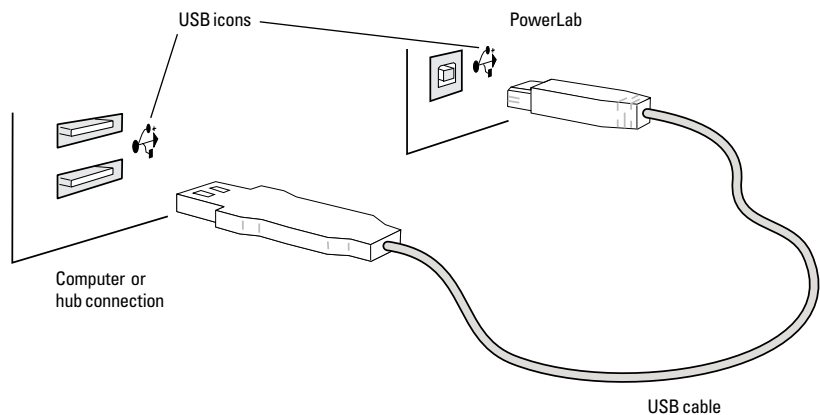

Connecting Macintosh or Windows computers should be much the same in this case: just look for the icons. However, if the connection is to a USB card that was installed in the computer, there might not be any icons visible.





# Technical Aspects

This appendix describes some of the important technical aspects of the PowerLabs of the /35 series, to give some insight into how they work. You do not need to know the material here to use your PowerLab. It is likely to be of interest to the technically minded, indicating what the PowerLab can and cannot do, and its suitability for particular purposes. You should not use it as a service manual: remember that user modification of the PowerLab voids your rights under warranty.

---

## How it Works

The PowerLab is essentially a device specifically designed to perform the various functions needed for data acquisition, signal conditioning, and pre-processing. It contains its own microprocessor, memory and specialized analog amplifiers for signal conditioning.

Sampling, output and communication functions are controlled by the internal PowerPC microprocessor, which runs at 240 MHz and can access 16 MB of internal dynamic RAM for data storage and buffering. PowerLabs use USB 2.0 to communicate with the computer, providing data transfer rates of up to 480 Mbits per second. If the computer only supports USB 1.1, the data transfer rate will be slower.

The analog inputs of the PowerLab are used to record external signals prior to digitizing. The outputs of the input amplifiers are multiplexed to a 16-bit ADC (analog-to-digital converter). The ADC can sample at up to 400,000 samples per second. The sampling process is handled independently of the processor core through a sampling control engine using direct memory access. The CPU assembles groups of samples into blocks and then transmits them to the computer, where the software receives, records and displays the data.

The external trigger input allows either a voltage level or a contact closure to trigger recording. Note: for either mode, the trigger signal must be present for at least 5  $\mu$ s to register as an event. When a trigger event occurs, the trigger indicator light will glow yellow.

Two 16-bit DACs (digital-to-analog converter) are used to provide analog output, or stimulation, through the analog outputs of the PowerLab. The DACs can produce constant DC voltage levels or waveforms under software control. Stimulation frequency is completely independent of the analog input sampling rate. The output of the DACs are fed through a programmable attenuation network to produce different output ranges. The signal is then split into a positive and negative output through buffer amplifiers. The outputs are capable of driving up to 50 mA into a load.

PowerLabs are also fitted with an I<sup>2</sup>C expansion port. This 9-pin port allows ADInstruments front-ends to be added to the system. It provides both power and communications to allow software control of the attached hardware.

The digital input and output connectors allow the PowerLab to monitor and control external devices, respectively. The digital input monitors state changes; the eight lines of the connector allow monitoring of up to eight devices. The digital output can turn on and off external devices or can signal

---

to some other device; the eight lines of the connector allow control of up to eight devices.

The PowerLab uses an IEC60601-1 (medically) compliant switching power supply. This provides a universal input that handles all common international voltage supplies and frequencies without the need to change voltage ranges. This power supply is also internally protected in the case of a problem. It is important to note that the PowerLab has a limited amount of power available for external devices. Because of these power limitations, you should not use the PowerLab as a power source for external devices other than those produced by ADInstruments.

## The Analog Inputs

PowerLab input amplifiers have been designed with a considerable amount of computer-controlled gain (up to  $\times 2000$ ). Thus it is possible to record a variety of signals without any external pre-amplification. Each analog input has a separate DC amplifier, with programmable gain able to be set independently (the gain is set through the software range control: the less the range, the more the gain). Inputs 1 – 4 of /35 series PowerLabs can be set by the software to be either single-ended or differential. In the differential setting, the amplifier measures the difference between the positive and negative inputs of a pod connector, irrespective of ground. Differential signals can only be recorded using a pod connector; the BNC analog inputs on the PowerLabs are all single-ended, and the difference is to the ground.

When recording from single-ended sources, it is recommended that the Input(+) ref of the pod connector be used instead of the Analog ground as this configuration can act to reduce common-mode interference (see Figure A-4).

It is important to note that the PowerLab grounds the inputs to amplifiers not in use. It also grounds each amplifier and measures the DC offset voltage when the gain is changed. In this way, the software corrects for any DC drift or offset in the circuits that may develop over time or between readings.

The input amplifiers can be set to pass both DC and AC signals, or to pass only AC signals without passing DC signals. Input impedance is one megohm ( $1\text{ M}\Omega$ ).

On /35 series PowerLabs, the impedance between the earthing stud (ground connection) and the input connector grounds is 100 Ohms.

Each analog input is fitted with a fixed 25 kHz low-pass filter.

**⚠ Caution**  
*Applying more than  $\pm 15\text{ V}$  to the input can damage the input circuits.*

**⚠ WARNING**  
*PowerLab analog inputs and outputs are not electrically isolated. Human subjects must not be connected to the PowerLab analog outputs and inputs either directly, or with uninsulated transducers. If such measurements are to be made, an electrically isolated ADInstruments front-end, insulated transducer or other approved electrically isolated device must be used (for example, the Bio Amp inputs or Isolated Stimulator outputs on some PowerLabs and front-ends)*

## The Analog Outputs

The analog outputs provide computer-controlled variable voltage output that can be used with LabChart and Scope applications, either directly, as a stimulator, or to control peripheral devices. All voltage output is generated by the PowerLab and delivered via the BNC output sockets, giving positive, negative, differential, or independent stimuli, depending on the sockets used and the software settings.

**Figure A-1**  
The analog output stage, set up for a differential stimulus

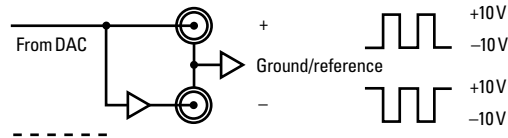

By default, the outputs deliver complementary (differential) stimulation. Output 1 is positive and Output 2 is negative. When only Output 1 is used, positive stimuli (set up in LabChart or Scope) gives positive voltage output, and negative stimuli gives negative voltage output. When only Output 2 is used, voltage outputs are inverted. When both outputs are used in differential mode, the stimulus is the difference between the voltages at the positive and negative outputs, giving up to 20 V, with a  $\pm 10$  V setting.

Output 1 and Output 2 can also function independently. With a Stimulator front-end such as a Stimulus Isolator or Stimulator HC connected to the positive output (Output 1), the second output (Output 2) can function independently. Hence, in LabChart 7 for Windows, a second tab appears in the Stimulator dialog. Therefore Output 2 remains available for other uses, such as creating analog waveforms and triggering other systems. This feature is not yet available in LabChart 7 for Macintosh.

## PowerLab Accuracy

The PowerLab was calibrated at the factory to an accuracy of better than 0.1%. Some 'zero drift' or 'gain drift' can occur with time. This can affect the accuracy of measurements, especially at the highest input gains. The unit can be recalibrated but in most circumstances this is not necessary in its lifetime. Two reasons are explained below.

**DC drift compensation.** Each time that a recording is started, either manually or by triggering, or the gain is changed, the input to the amplifier is grounded and any DC offset due to the amplifier's drift with temperature and age is measured. The measured voltage is removed from the readings for that input through software correction, in a process that is transparent to the user.

**Calibration facilities.** It is good practice to calibrate a measuring system from transducer to output. After applying two known values to the transducer and recording both signals, use the units conversion feature in the ADInstruments software to calibrate the transducer and display readings in the appropriate units. This will compensate for any minor inaccuracies in amplifier gain and transducer calibration.

## The External Trigger

The external trigger provides an input for synchronizing sampling to external devices. It allows either a voltage level or a contact closure to trigger recording. Note: the trigger signal length must be at least 5  $\mu\text{s}$ . When a trigger event occurs, the trigger indicator light glows yellow.

In the voltage level mode, the level above which a rising edge trigger event is registered is 1.5 V  $\pm$  0.5 V (1.1 V for a falling edge). The trigger input is off for voltages between -12 V and that level, and on between that level and +12 V. The input is overloaded outside the range -12 V to +12 V. The trigger input is isolated when set up for a voltage level.

**Figure A-2**  
The equivalent circuit of the external trigger input, set up for a voltage level

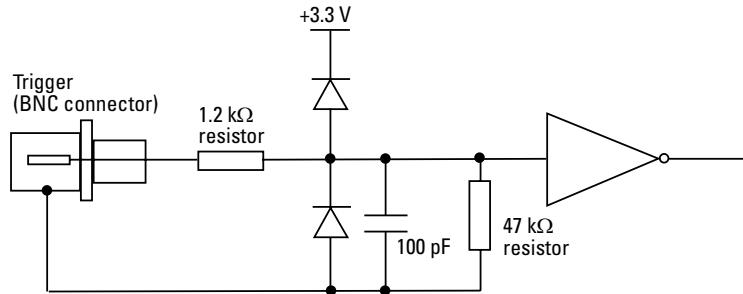

In the contact closure mode, the trigger input will respond to a direct short between the center pin and outer ring of the BNC. This can be achieved with an external relay contact, push-button or microswitch. The trigger input is not isolated when set up for contact closure.

**Figure A-3**  
The equivalent circuit of the external trigger input, set up for contact closure

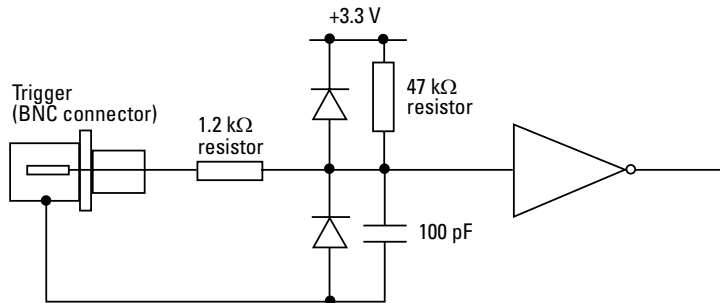

In order for the external trigger to work, a voltage must be applied between the outer ring and the inner pin of the connector. Applying a voltage just to the center pin may not work. The source must be capable of supplying at least 100  $\mu\text{A}$  of current to activate the trigger.

## Connections

This section contains ‘pinout’ and electrical details of some of the connectors of the PowerLab. Read it carefully before attempting to connect cables to the PowerLab, other than those that came with the unit. Using cables that are wired incorrectly can cause internal damage to the PowerLab and voids your rights under warranty.

### Pod Connectors

The (8-pin DIN) pod connectors on Inputs 1 – 4 of the /35 series PowerLabs allow the connection of ADInstruments pods, which are small, low-cost units that provide alternatives to front-ends for specific tasks, for use with precalibrated transducers and so on. Transducers should not be connected directly to pod connectors, unless labeled to do so (unsuitable transducers will give a very weak signal). However, transducers designed for direct connection receive power and control, since the pod connectors provide some functions of the I<sup>2</sup>C socket.

When recording from single-ended sources, using the Input(+) ref of the pod connector instead of Analog ground can reduce common-mode interference.

Do not attempt to record from both the BNC and pod connector of the same input at the same time, or the signals will compete.

**Figure A-4**  
The pin assignments for  
the Pod connector

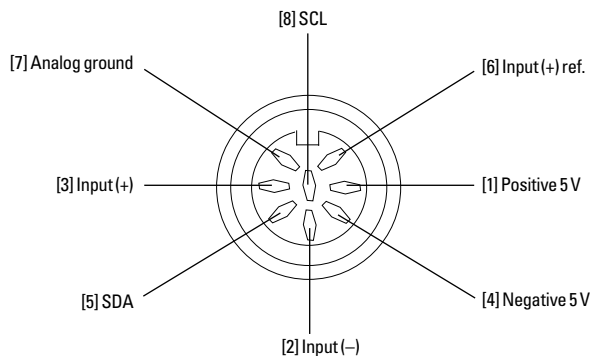



## Serial Port

The PowerLab is fitted with an RS-485 serial communication port. It is not currently used, but is meant for connection in the future to specialized devices controlled from the PowerLab system. The serial port provides a differential, bidirectional serial connection for external devices supporting the RS-485 standard. The port also provides three power supplies and a ground signal.

### ⚠ WARNING

*Do not connect more than 16 channels of front-ends or instruments to the I<sup>2</sup>C port as it may overload the PowerLab. For example, two Octal Bridge Amps or four Quad Bridge Amps would give a total of 16 channels so no further equipment should be added to the I<sup>2</sup>C port.*

## I<sup>2</sup>C Expansion Socket

The I<sup>2</sup>C socket on the back panel of the PowerLab provides expansion support for ADInstruments front-ends. This 9-pin socket provides both power and control signals for many front-ends. The I<sup>2</sup>C bus has a daisy-chain structure that allows simple connection of additional front-ends to the system. Although a PowerLab can have as many front-ends connected as it has appropriate input channels, the I<sup>2</sup>C socket can support a maximum of 16 single-channel front-ends.

You should not attempt to run other external devices from the I<sup>2</sup>C socket as it is designed for use only with ADInstruments front-ends.

**Figure A-5**  
The pin assignments for the I<sup>2</sup>C port

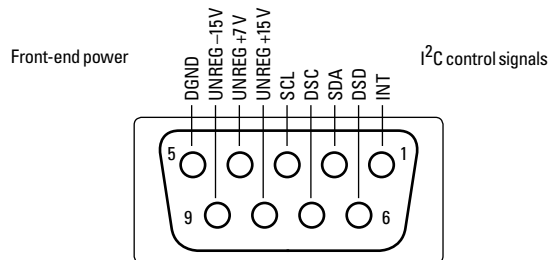

## Digital Input and Output Sockets

The digital input and digital output sockets are 15-pin connectors situated on the back panel of the PowerLab. The eight digital input lines respond to 3.3 V logic signals with a threshold of 1.2 V, and have a 1 k $\Omega$  input impedance. The eight digital output lines can turn on and off, or signal to, up to eight external TTL devices. The digital output lines are capable of driving 8 mA each. The inputs and outputs conform to industry standard HCMOS structures powered with a 5 V supply. The digital input and output sockets both have a pin which can supply power to solid-state relays or similar devices. Total aggregate current from these pins is 200 mA continuous at 5 V. The digital input signals should not exceed 5 V.

**Figure A-6**  
The pin assignments  
for the digital input  
(left) and output (right)  
connectors

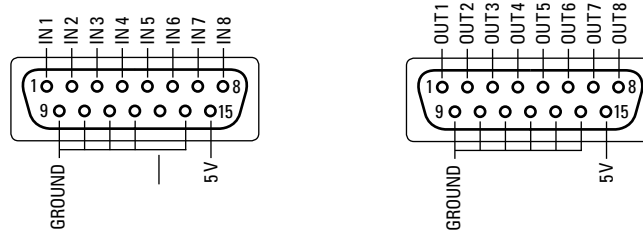

## USB Connections

PowerLabs have a USB 2.0 port, and connect to a computer with USB ports or a PCI USB card installed, allowing high data transfer rates to USB 2.0-compliant computers (slower transfer to USB 1.1-compliant computers). On a PC, USB 1.1 requires Windows 98 or later. On a Macintosh, USB needs a Power Macintosh with Mac OS 8.5 or later.

**Figure A-7**  
The USB icon and port



The signal must be transmitted in a certain time; in practical terms this means cables between any USB devices, including hubs, must be no more than 5 meters (16 feet) in length, and with hubs in the chain, devices must be no more than 30 meters (98 feet) from the computer. For proper use and reliable results, the PowerLab needs a high-speed connection. Your PowerLab is supplied with a high-speed USB cable. If you replace the USB cable, buy a high-speed cable (fully shielded, twisted-pair and standard USB connections: a narrow rectangular plug at one end and a square plug with a bevelled top at the other).

When devices that transfer a lot of information, such as scanners and video cameras, are connected to the same USB tree and are used at the same time as a PowerLab, sampling rates may be limited considerably (in LabChart) or delay times between sweeps may increase (in Scope). Newer computers (both PC and Macintosh) usually have several independent USB ports. Using these, rather than a hub, to connect multiple devices will avoid them competing for capacity (bandwidth).

You can safely turn on or off, or disconnect or reconnect, a USB-connected PowerLab while the computer remains on, as long as the application program (LabChart or Scope) is off when you do it.

## Earthing and Ground Loop Noise

The prime function of earthing is safety, that is, protection against fatal electrocution. Safety concerns should always override concerns about signal quality. Secondary functions of earthing are to provide a reference potential for the electrical equipment and to mitigate against interference.

---

The earthing (grounding) stud provided on the back panel of the PowerLab is a potential equalization post and is compatible with the DIN 42801 standard. It is directly connected to the earth pin of the power socket and the PowerLab chassis. The earthing stud can be used where other electronic equipment is connected to the PowerLab, and where conductive shields are used to reduce radiative electrical pick-up. Connection to the stud provides a common earth for all linked devices and shields, to reduce ground-loops.

The earthing stud can also be used where a suitable ground connection is not provided with the mains supply by connecting the stud to an earthed metal infra-structure, such as a metal stake driven into the ground, or metal water piping. This may also be required in laboratories where safety standards require additional grounding protection when equipment is connected to human subjects. Always observe the relevant safety standards and instructions.

Note that magnetically-induced interference in the recorded signal can be reduced by minimizing the loop area of signal cables, for example by twisting them together, or by moving power supplies away from sensitive equipment. This can reduce the inductive pick-up of mains frequency fields. Please consult a good text for further discussion of noise reduction.



# B

## Specifications

Number of inputs:	4/35:	4; Single-ended and differential;
	8/35:	8; Inputs 1 – 4 are single-ended and differential; Inputs 5 – 8 are single-ended
	16/35:	16; Inputs 1– 4 are single-ended and differential; Inputs 5 – 16 are single-ended
Input configuration:		Single-ended or differential (the latter only through the pod connectors)
Amplification ranges:		±2 mV to ±10 V full scale in 12 steps:
	Range	Resolution      Noise (rms)
	±10 V	313 µV      1 LSB
	±5 V	156 µV      1 LSB
	±2 V	62.5 µV      1.5 LSB
	±1 V	31.3 µV      1 LSB
	±0.5 V	15.6 µV      1 LSB
	±0.2 V	6.25 µV      1.5 LSB
	±0.1 V	3.13 µV      1.5 LSB
	±50 mV	1.56 µV      2 LSB
	±20 mV	625 nV      2.4 µV
	±10 mV	312 nV      2.4 µV
	±5 mV	156 nV      2.2 µV
	±2 mV	62.5 nV      2.2 µV
Maximum input voltage:		±15 V
Input impedance:		~ 1 MΩ    100 pF
Low-pass filters:		1 Hz to 1 kHz in 2.5:10 steps; 2 kHz, 25 kHz
AC coupling:		DC or 0.15 Hz (software-selectable)
Frequency response (-3 dB):		25 kHz on the ±10 V range

DC drift:	Software corrected
CMRR:	100 dB @ 100 Hz (differential mode, 100 mV – 2 mV range)
Input crosstalk:	75 dB minimum
Input noise:	< 350 $\mu$ Vrms referred to input on the $\pm 10$ V range

### **Pod Connectors**

General features:	Combined power, I <sup>2</sup> C and single-ended or differential analog input on one connector, supports SmartPod transducers, etc.
Supply voltage:	$\pm 5$ V regulated
Maximum current:	50 mA per pod port
Communications:	2-wire I <sup>2</sup> C
Signal input:	Positive and negative analog inputs
Connector type:	8-pin DIN

### **Sampling**

ADC resolution:	16 bits (313 $\mu$ V resolution on the $\pm 10$ V range)
Linearity error:	$\pm 2.5$ LSB
Maximum sampling rates:	200 kHz using one or two input; 100 kHz using three or four inputs; 40 kHz using five to eight inputs; 20 kHz using nine to sixteen inputs.

### **Analog Outputs**

Number of outputs:	2
Output configuration:	Single-ended (outputs can be used as one differential output)
ADC resolution:	16 bits (313 $\mu$ V resolution on the $\pm 10$ V range)
Maximum output current:	$\pm 50$ mA
Output impedance:	0.5 $\Omega$ typical
Settling time:	10 $\mu$ s (to 1% of FSR)

Slew rate:	6 V/ $\mu$ s
Linearity error:	$\pm 4$ LSB
Output ranges:	$\pm 200$ mV to $\pm 10$ V full scale in six steps:

Range	Resolution
$\pm 10$ V	313 $\mu$ V
$\pm 5$ V	156 $\mu$ V
$\pm 2$ V	62.5 $\mu$ V
$\pm 1$ V	31.3 $\mu$ V
$\pm 500$ mV	15.6 $\mu$ V
$\pm 200$ mV	6.25 $\mu$ V

### External Trigger

Trigger mode:	TTL level or contact closure (non-isolated), software selectable.
Trigger threshold:	+1.3 V (rising edge), +1.1 V (falling edge)
Hysteresis:	0.6 V
Input impedance:	50 k $\Omega$
Maximum input voltage:	$\pm 12$ V
Minimum event time:	5 $\mu$ s

### Microprocessor and Data Communication

Processor:	PowerPC 405GPr @ 240 MHz
Memory:	16 MB SDRAM
Data communication:	USB 2.0

### Expansion Ports

I <sup>2</sup> C expansion port:	Power and control bus for front-end units. Supports a number of front-ends equal to the number of PowerLab analog inputs. Interface communications rate of up to 10 Kbits/s.
Digital output:	8 independent lines, TTL output level (8 mA maximum load per line)
Digital input:	8 independent lines, TTL input level, threshold 1.2 V, 10 k $\Omega$ input impedance, 5 V maximum

---

## Physical Configuration

Dimensions (h × w × d): 70 mm × 240 mm × 260 mm  
(2.76" × 9.45" × 10.2")

Weight:

4/35:	2.7 kg (5 lb 15 oz)
8/35:	2.7 kg (5 lb 15 oz)
16/35:	2.9 kg (6 lb 6 oz)

## Operating Requirements

Operating voltage: 90–250 V (automatic)

Maximum power needs: 80 VA (PowerLab 4/35 and 8/35; assuming worst-case I<sup>2</sup>C loading)

90 VA (PowerLab 16/35 only; assuming worst-case I<sup>2</sup>C loading)

Operating conditions: 5–35 °C, 0–90% humidity (non-condensing)

Storage/transport conditions: 0–40 °C, 0–95% relative humidity

## Safety

Device classification: Class I device

Unsuitable uses: Do not use in the presence of flammable anaesthetic-air mixtures. Avoid operating near high voltage, RF or magnetic fields that may cause interference. Equipment is not suitable for use in the presence of a flammable anaesthetic mixture with air or with oxygen or nitrous oxide

Operation: Continuous

Applied parts: None

*ADInstruments reserves the right to alter these specifications at any time.*



---

## **Electromagnetic Compatibility**

The PL3504 PowerLab 4/35, PL3508 PowerLab 8/35 and PL3516 PowerLab 16/35 have been tested to comply with the requirements of EN61326-1:2006, IEC 61000-3-2, IEC 61000-3-3, IEC 61000-4-2, IEC 61000-4-3, IEC 61000-4-4, IEC 61000-4-5, IEC 61000-4-6, IEC 61000-4-8, IEC 61000-4-11 and CISPR 11. The Electromagnetic compatibility (EMC) meets standard EN61326-1:2006.

### **Emissions**

- The devices use RF energy for their internal function only. RF emissions are very low and are not likely to cause any interference in nearby electronic equipment.
- The devices are suitable for use in all establishments, including domestic establishments and those directly connected to the public low-voltage power supply network that supplies buildings used for domestic purposes.

### **Immunity**

- Mains power quality should be that of a typical commercial or hospital environment. If the user of the devices requires continued operation during power mains interruptions, it is recommended that the devices be powered from an uninterruptible power supply or a battery.
- Power frequency magnetic fields should be at levels characteristic of a typical location in a typical commercial or hospital environment.
- Floors should be wood, concrete or ceramic tile. If floors are covered with synthetic material, the relative humidity should be at least 30%.

### **Separation Distances**

- The devices are intended for use in an electromagnetic environment in which radiated RF disturbances are controlled.
- Portable and mobile RF communications equipment should be used no closer to any part of the devices, including cables, than the recommended separation distance in the table below.
- Field strengths from fixed RF transmitters, as determined by an electromagnetic site survey, should be less than the compliance level in each frequency range.

Rated maximum output power of transmitter, P	Separation distance	
	150 kHz to 800 MHz $d = 1.17\sqrt{P}$	800 MHz to 2.5 GHz $d = 2.33\sqrt{P}$
0.01 W	0.1 m	0.2 m
0.1 W	0.4 m	0.7 m
1 W	1.2 m	2.3 m
10 W	3.7 m	7.4 m
100 W	11.7 m	23.4 m

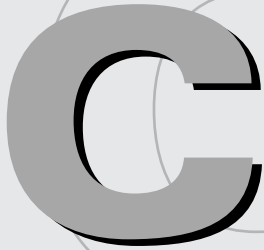
A large, stylized, grey letter 'C' is positioned on the left side of the header. It is partially enclosed by a thin, light grey circular outline that overlaps the top and right sides of the letter.

# Declaration of Conformity

A Declaration of Conformity covering 2004/108/EC Electromagnetic Compatibility (EMC) and 2006/95/EC Low Voltage Equipment directives is presented on the next page.

# DECLARATION OF CONFORMITY

**The manufacturer of the product(s) covered by this declaration is:**

**Name:** ADInstruments Pty Ltd  
**Address:** Unit 13/22 Lexington Drive  
Bella Vista NSW 2153  
Australia

**The products covered by this declaration are:**

Product name: Powerlab 4/35, Powerlab 8/35, Powerlab 16/35  
Model number(s): PL3504, PL3508, PL3516

**Directives covered by this declaration:**

2004/108/EC Electromagnetic Compatibility (EMC) directive  
2006/95/EC Low Voltage Equipment directive

**Basis of Conformity:**

ADInstruments Pty Ltd hereby declares that the products identified above comply with the protection requirements of the EMC directive and with the principal elements of the safety objectives of the Low Voltage Equipment directive. The following standards have been applied:

**IEC 60601-1:1988 + A1:1991 + A2:1995, CAN/CSA-C22.2 No. 601.1-M90 (R2005) (includes National Differences for Canada), UL 60601-1, 1st Edition, 2006-04-26 (includes National Differences for USA),** (except EN 60601-1-2, Biocompatibility, EN 10993-1, Programmable Electronic Systems, IEC 60601-1-4)

**EN 61326-1:2006** Emissions: CISPR11 (Group 1, Class A), EN61000-3-2

Immunity: IEC61000-4-2, 3, 4, 5, 6, 8, 11

The technical documentation required to demonstrate that the products meet the requirements of the Low Voltage Equipment directive has been compiled and is held on EU territory available for inspection by the relevant enforcement authorities.

Signed:  \_\_\_\_\_

Authority:  \_\_\_\_\_

Date:  \_\_\_\_\_

**Attention!**

The attention of the specifier, purchaser, installer, or user is drawn to special measures and limitations to use which must be observed when these products are installed, taken into service, operated, and maintained, to maintain compliance with the above directives. Details of these special measures and limitations to use are available on request, and are contained in the product manuals.

# Glossary

**AC coupling.** A filter option. When AC coupling is chosen, a 0.1 Hz high-pass filter before the first amplification stage removes DC and frequency components below 0.1 Hz. This removes slowly changing baselines.

**ADC (analog-to-digital converter).** A device that converts analog information into some corresponding digital voltage or current.

**amplitude.** The maximum vertical distance of a periodic wave from the zero or mean position about which the wave oscillates.

**analog.** Varying smoothly and continuously over a range. An analog signal varies continuously over time, rather than changing in discrete steps.

**analog input.** This refers to the connectors on the front of the PowerLab marked 'Input'. These inputs are designed to accept up to  $\pm 10$  volts. Inputs can be either single-sided or differential (the latter only in the case of the pod connectors).

**analog output.** This refers to the connectors on the front of the PowerLab marked 'Output'. The analog output provides a software-controlled variable output ( $\pm 10$  V) that can be used with applications either directly as a stimulator, or to control peripheral devices. Not for use with human subjects.

**analysis.** When the PowerLab is not physically connected to the computer, then ADInstruments software can be used to analyze and manipulate existing files if the analysis option is chosen.

**BNC (bayonet nut connector).** A type of cable or connector; a BNC-to-BNC cable connects two BNC connectors.

**bridge transducer.** A type of transducer using a Wheatstone bridge circuit. In its basic form, the bridge consists of four two-terminal elements (usually strain gauges) connected to form a quadrilateral. An excitation

---

source is connected across one diagonal, and the transducer output is taken across the other.

**bus.** A data-carrying electrical pathway (cables and connectors).

**connector.** A plug, socket, jack or port used to connect one electronic device to another (via a cable): a PowerLab to a computer, say.

**CPU (central processing unit).** A hardware device that performs logical and arithmetical operations on data as specified in the instructions: the heart of most computers.

**DAC (digital-to-analog converter).** A device that converts digital information into some corresponding analog voltage or current.

**DC offset.** The amount of DC (direct current) voltage present at the output of an amplifier when zero voltage is applied to the input; or the amount of DC voltage present in a transducer in its equilibrium state.

**differential input.** Input using both positive and negative inputs on a PowerLab. The recorded signal is the difference between the positive and negative input voltages: if both were fed exactly the same signal, zero would result. Can reduce the noise from long leads.

**DIN (Deutsche Industrie Norm).** A type of cable or connector; there are various sorts with different numbers of pins.

**envelope form.** The overall shape of a signal, outlined by the minimum and maximum recorded values. Often used to display quickly changing signals.

**excitation voltage.** The voltage supplied to a bridge circuit from which the transducer output signal is derived. Manipulating the transducer changes the measurement elements of the bridge circuit, producing a change in its output voltage.

**external trigger.** The input connector on the front of the PowerLab marked 'Trigger'. This lets you start recording from an external source. The trigger level (the voltage needed to have an effect) depends on the hardware and cannot be changed. Recording can also be triggered by contact closure, if this is set up in the software.

**filter.** An electronic device or a program that alters data in accordance with specific criteria. Filters in hardware and software can be used to reduce or to eliminate electronic noise or drift from data readings.

**frequency.** The number of complete cycles per second of a waveform. Frequency is usually expressed in hertz: Hz (cycles per second), kilohertz: kHz (thousands of cycles per second), or megahertz: MHz (millions of cycles per second).

---

**frequency response.** The bandwidth in which a circuit passes a signal without too much attenuation. A low-pass filter's frequency response is the frequency where the output voltage becomes 0.707 ( $1/\sqrt{2}$ ) of the input voltage or has been attenuated by 3 decibels. If a low-pass filter has a frequency response of 200 Hz, say, then the signal is effectively unattenuated up to 150 Hz, and is 0.707 of the original value at 200 Hz.

**front-end.** An ancillary device that extends PowerLab capabilities, providing additional signal conditioning and features for specialized work. Front-ends are recognized automatically by the PowerLab system and seamlessly integrated into its applications, operating under full software control.

**gain.** The amount of amplification of a signal.

**half-bridge transducer.** A bridge transducer only using half of the full-bridge circuit. It consists of two elements of equal value with an excitation voltage applied across them. The output of the transducer is taken at the junction of the two elements.

**hertz (Hz).** The unit of frequency of vibration or oscillation, defined as the number of cycles per second. For example, the minimum sampling rate for a human ECG experiment should be 400 Hz (400 samples/s).

**high-pass filter (HPF).** A filter that passes high-frequency signals, but filters low ones, by blocking DC voltages and attenuating frequencies below a certain value (the cut-off, or  $-3$  dB, frequency).

**I<sup>2</sup>C ('eye-squared-sea').** This connection is used by the PowerLab to control front-ends. It provides power and communications using a 4-wire serial bus (two wires for standard I<sup>2</sup>C and two control lines).

**IEC.** International Electrotechnical Commission.

**LabChart.** An application supplied with a PowerLab that emulates a multi-channel chart recorder, with other powerful options. (Macintosh and Windows versions differ slightly.)

**LabTutor.** An ADInstruments application for teaching physiology that integrates the experiment protocol, real-time data acquisition, analysis and reporting as interactive pages in the Internet Explorer browser.

**LSB (least significant bit).** The least significant bit is often used to refer to the smallest voltage change that can be detected by an A/D converter

**low-pass filter (LPF).** A filter that passes low-frequency signals and DC voltages, but filters high ones, attenuating frequencies above a certain value (the cut-off, or  $-3$  dB, frequency).

---

**MacLab.** An earlier name for the PowerLab, before it became cross-platform.

**PCI (peripheral component interconnect).** A protocol for connecting peripheral devices (such as USB cards) to computers and so on.

**pod connector.** A special 8-pin DIN connector on some PowerLabs giving differential or single-sided connections for some analog inputs (Inputs 1 - 4 on the PowerLab 8/35 and PowerLab 16/35). Pods can connect to them, and they can also provide power and control for some types of transducers.

**Pods.** Small, low-cost units that connect to the PowerLab's pod connectors. They give alternatives to front-ends for specific tasks, for use with precalibrated transducers and so on.

**port.** A socket where you plug in a cable for connection to a network or a peripheral device. Also, any connection for transferring data, for instance between the CPU and main memory.

**PowerLab.** The PowerLab hardware unit is a self-contained data acquisition hardware unit that connects to a Windows or Macintosh computer. When used in conjunction with programs such as LabTutor, LabChart and Scope, it functions as a versatile laboratory instrument.

**PowerLab system.** The system consists of a hardware unit and applications software (and possibly ancillary devices). It provides a multi-purpose data recording, display, and analysis environment for experimental data.

**range.** In LabChart and Scope, the range is the greatest positive and negative voltage that can be displayed, usually from  $\pm 5$  mV to  $\pm 10$  V, in 11 steps. (Range is inversely proportional to gain, the extent of amplification.)

**Scope.** An application supplied with a PowerLab that emulates a two-channel storage oscilloscope, with added powerful options. (Macintosh and Windows versions are very similar.)

**serial.** A connection protocol for sending information sequentially, one bit at a time, over a single wire.

**transducer.** A physical device that converts a mechanical, thermal or electrical stimulus into a proportional electrical output. For example, there are common transducers to measure force, displacement, temperature, pressure, and similar parameters.

**trigger.** A signal, such as a voltage pulse, used to determine when sampling will begin. Sampling can be made to begin when the trigger level is reached, after it, or even prior to it. See also external trigger.



---

**TTL (transistor-transistor logic).** A family of integrated circuits (ICs) with bipolar circuit logic, used in computers and related devices. TTL is also a standard for interconnecting such ICs, defining the voltages used to represent logical zeroes and ones (binary 0 and 1).

**USB.** Universal Serial Bus.

**waveform.** The shape of a wave; a graph of a wave's amplitude over time.

